

# Elite AT-1

## USER MANUAL



Optical Audio



AUX IN



Full Range  
Drivers



Bluetooth  
Audio



Equaliser



Remote Control



USB MP3



**AZATOM**  
NEXT GENERATION SOUND





# Contents

<b>1. Important Safety Instructions</b> .....	<b>4</b>
1.1 Safety.....	4
1.2 Caution.....	5
1.3 Warning.....	5
<b>2. What's in the Box</b> .....	<b>6</b>
<b>3. Identifying the Parts</b> .....	<b>7</b>
3.1 Soundbar.....	7
3.2 Remote Control.....	8
<b>4. Preparations</b> .....	<b>8</b>
4.1 Prepare the Remote Control.....	8
4.2 Replace the Remote Control Battery.....	8
<b>5. Placement and Mounting</b> .....	<b>9</b>
5.1 Placement.....	9
5.2 Wall Mounting (if using option-B).....	9
<b>6. Connections</b> .....	<b>10</b>
6.1 Dolby Atmos®.....	10
6.2 HDMI Connection.....	10
6.3 Use the OPTICAL Socket.....	10
6.4 Use the COAXIAL Socket.....	11
6.5 Use the AUX Socket.....	11
6.6 Connect Power.....	11
<b>7. Basic Operation</b> .....	<b>11</b>
7.1 Standby/ON.....	11
7.2 Automatic Power Off Function.....	11
7.3 Select Modes.....	11
7.4 Adjust the Bass/Treble Level.....	11
7.5 Turn the Surround Sound ON/OFF.....	12
7.6 Select Equalizer (EQ) Effect.....	12
7.7 Adjust the Volume.....	12
7.8 Adjust the Brightness.....	12
<b>8. AUX/OPTICAL/COAXIAL/ HDMI Operation</b> .....	<b>12</b>
<b>9. USB Operation</b> .....	<b>12</b>
<b>10. Bluetooth® Operation</b> .....	<b>13</b>
<b>11. Troubleshooting</b> .....	<b>14</b>
<b>12. Specifications</b> .....	<b>15</b>

# 1. Important Safety Instructions

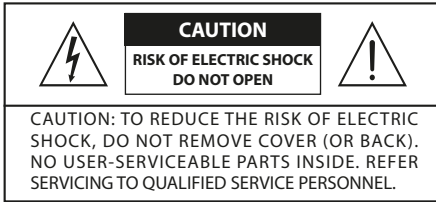



The lightning flash with arrowhead symbol, within an equilateral triangle, is intended to alert the user to the presence of uninsulated "dangerous voltage" within the product's enclosure that may be of sufficient magnitude as to constitute a risk of electric shock to persons.



The exclamation point within an equilateral triangle is intended to alert the user to the presence of important operating and maintenance (servicing) instructions in the literature accompanying the appliance.

## 1.1 Safety

- 1 Read these instructions** – All the safety and operating instructions should be read before this product is operated.
- 2 Keep these instructions** – The safety and operating instructions should be retained for future reference.
- 3 Heed all warnings** – All warnings on the appliance and in the operating instructions should be adhered to.
- 4 Follow all instructions** – All operating and usage instructions should be followed.
- 5 Do not use this apparatus near water** – The appliance should not be used near water or moisture – for example, in a wet basement or near a swimming pool and the like.
- 6 Clean only with a dry cloth.**
- 7 Do not block any ventilation openings.** Install in accordance with the manufacturer's instructions.
- 8 Do not install near any heat sources such as radiators, heaters, stoves, or other apparatus (including amplifiers) that produce heat.
- 9 Do not defeat the safety purpose of the polarized or grounding plug. A polarized plug has two blades with one wider than the other. A grounding plug has two blades and a third grounding prong. The wide blade or the third prong is provided for your safety.
- 10 Protect the power cord from being walked on or pinched particularly at plugs, convenience receptacles, and the point where they exit from the apparatus.
- 11 Only use attachments/accessories specified by the manufacturer.
- 12  Use only with the cart, stand, tripod, bracket or table specified by the manufacturer, or sold with the apparatus. When a cart or rack is used, use caution when moving the cart/apparatus combination to avoid injury from tip-over.
- 13 Unplug the apparatus during lightning storms or when unused for long periods of time.
- 14 Refer all servicing to qualified personnel. Servicing is required when the apparatus has been damaged in any way, such as power supply cord or plug is damaged, liquid has been spilled or objects have fallen into the apparatus, the unit has been exposed to rain or moisture, does not operate normally, or has been dropped.
- 15  This equipment is a Class II or double insulated electrical appliance. It has been designed in such a way that it does not require a safety connection to electrical earth.
- 16 The apparatus shall not be exposed to dripping or splashing. No objects filled with liquids, such as vases, shall be placed on the apparatus.
- 17 Minimum distance around the apparatus for sufficient ventilation is 5cm.
- 18 The ventilation should not be impeded by covering the ventilation openings with items, such as newspapers, table-cloths, curtains, etc...
- 19 No naked flame sources, such as lighted candles, should be placed on the apparatus.
- 20 Batteries should be recycled or disposed of as per state and local guidelines.
- 21 The use of apparatus in moderate climates.

## 1.2 Caution

- Use of controls or adjustments or performance of procedures other than those described herein, may result in hazardous radiation exposure or other unsafe operation.
- To reduce the risk of fire or electric shock, do not expose this apparatus to rain or moisture. The apparatus must not be exposed to dripping or splashing and objects filled with liquids, such as vases, must not be placed on apparatus.
- The mains plug/appliance coupler is used as the disconnect device, the disconnect device must remain readily operable.
- Danger of explosion if battery is incorrectly replaced. Replace only with the same or equivalent type.

## 1.3 Warning

- The battery (batteries or battery pack) shall not be exposed to excessive heat such as sunshine, fire or the like.
- Before operating this system, check the voltage of this system to see if it is identical to the voltage of your local power supply.
- Do not place this unit close to strong magnetic fields.
- Do not place this unit on the amplifier or receiver.
- If any solid object or liquid falls into the system, unplug the system and have it checked by qualified personnel before operating it any further.
- Do not attempt to clean the unit with chemical solvents as this may damage the finish. Use a clean, dry or slightly damp cloth.
- When removing the power plug from the wall outlet, always pull directly on the plug, never yank on the cord.
- Changes or modifications to this unit not expressly approved by the party responsible for compliance will void the user's authority to operate the equipment.
- The rating label is pasted on the bottom or back of the equipment.

### **Battery usage CAUTION**

To prevent battery leakage which may result in bodily injury, property damage, or damage to the apparatus:

- Install all batteries correctly, + and - as marked on the apparatus.
- Do not mix old and new batteries.
- Do not mix alkaline, standard (Carbon-Zinc) or rechargeable (Ni-Cd, Ni-MH, etc.) batteries.
- Remove batteries when the unit is not used for a long time.



Correct Disposal of this product. This marking indicates that this product should not be disposed with other household wastes throughout the EU. To prevent possible harm to the environment or human health from uncontrolled waste disposal, recycle it responsibly to promote the sustainable reuse of material resources. To return your used device, please use the return and collection systems or contact the retailer where the product was purchased. They can take this product for environmental safe recycling.



We hereby declares that this product is in compliance with the essential requirements and other relevant provisions of RED Directive 2014/53/EU and UK Radio Equipment Regulations 2017.



The Bluetooth® word mark and logos are registered trademarks owned by Bluetooth SIG, Inc. and any use of such marks by Azatom is under license. Other trademarks and trade names are those of their respective owners.



The terms HDMI, HDMI High-Definition Multimedia Interface, HDMI trade dress and the HDMI Logos are trademarks or registered trademarks of HDMI Licensing Administrator, Inc.



Dolby, Dolby Atmos, and the double-D symbol are registered trademarks of Dolby Laboratories Licensing Corporation. Manufactured under license from Dolby Laboratories. Confidential unpublished works. Copyright © 2012-2024 Dolby Laboratories. All rights reserved.

## 2. What's in the Box

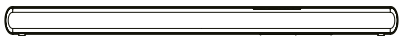

Sound bar

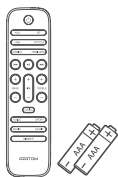

Remote Control /  
AAA Batteries x 2



AC Power Cord



3.5mm to 3.5mm  
Audio Cable



Instruction Manual

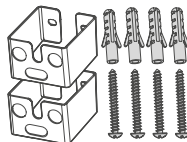

Wall Bracket



Wall mounting Screw

- Power cord quantity and plug type vary by regions.
- Images, illustrations and drawings shown on this User Manual are for reference only, actual product may vary in appearance.

# 3. Identifying the Parts

## 3.1 Soundbar

TOP

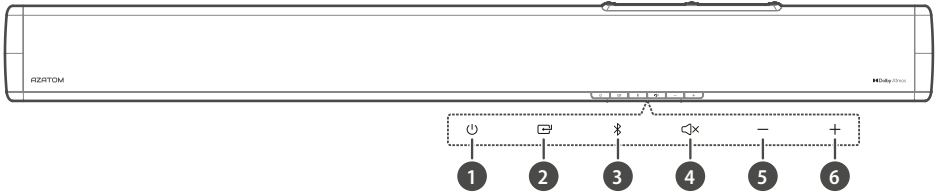

FRONT

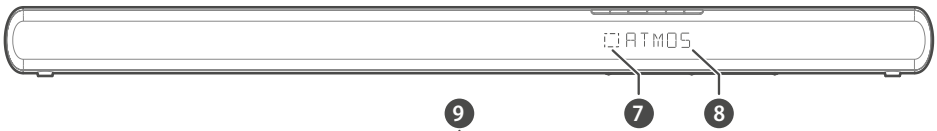

BACK





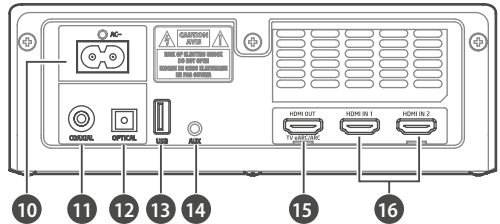

- 1 **⏻ (ON/OFF) button**  
Switch the Soundbar between ON and Standby mode.
- 2 **◀ (SOURCE) button**  
Select the play function.
- 3 **📶 (Bluetooth)**  
Select the Bluetooth mode.  
Press and hold to activate the pairing function in Bluetooth mode or disconnect the existing paired Bluetooth device.
- 4 **🔇**  
Mute or resume the sound.
- 5 **- (volume)**  
Decrease the volume level.
- 6 **+ (volume)**  
Increase the volume level.
- 7 **Remote Control Sensor**  
Receive signal from the remote control.
- 8 **Display Window**  
Show the current status.
- 9 **Wall bracket screws**
- 10 **AC~ Socket**
- 11 **COAXIAL Socket**  
Use to connect the soundbar to a COAXIAL OUT socket on an external device.



- 12 **OPTICAL Socket**  
Use to connect the soundbar to a OPTICAL OUT socket on an external device.
- 13 **USB Socket**  
Insert the USB device to play music.
- 14 **AUX Socket**  
Connect to an external audio device.
- 15 **HDMI OUT (TV eARC/ARC) Socket**  
The port supports the eARC/ARC HDMI feature, which allows the soundbar to play audio that originates on the connected TV.
- 16 **HDMI IN (1/2) Sockets**  
Two HDMI ports for connecting HDMI source devices, such as a DVD player, Blu-ray Disc™ player, or gaming console. Note that only one HDMI input is usable at a time.

### 3.2 Remote Control

- 1  Switch the Soundbar between ON and STANDBY mode.
- 2 **SOURCE buttons** Select the play function.
- 3   Skip to previous/next track in Bluetooth/USB mode.
-  Play/pause/resume playback in Bluetooth/USB mode.
- Press and hold to activate the pairing function in Bluetooth mode or disconnect the existing paired Bluetooth device.
- 4 **BASS +/-** Adjust bass level.
- 5 **TREBLE +/-** Adjust treble level.
- 6  **(MUTE)** Mute or resume the sound.  
**+/- (VOL)** Increase/decrease the volume level.
- 7 **VERTICAL/SURROUND** Adjust the surround ON/OFF.
- 8 **EQ buttons** Select Equalizer (EQ) Effect.
- 9 **DIMMER** Adjust display brightness.

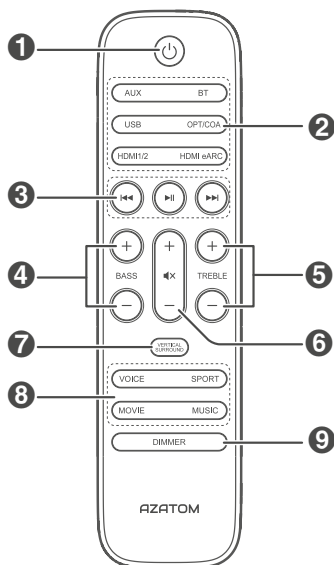

## 4. Preparations

### 4.1 Prepare the Remote Control

The provided Remote Control allows the Soundbar to be operated from a distance.

- Even if the Remote Control is operated within the effective range 19.7 feet (6m), remote control operation may be impossible if there are any obstacles between the Soundbar and the remote control.
- If the Remote Control is operated near other products which generate infrared rays, or if other remote control devices using infrared rays are used near the Soundbar, it may operate incorrectly. Conversely, the other products may operate incorrectly.

### 4.2 Replace the Remote Control Battery

- 1 Press and slide the back cover to open the battery compartment of the remote control.
- 2 Insert two **AAA** size batteries (included). Make sure the (+) and (-) ends of the batteries match the (+) and (-) ends indicated in the battery compartment.
- 3 Close the battery compartment cover.

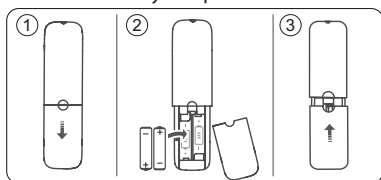

### Precautions Concerning Batteries

- Be sure to insert the batteries with correct positive “+” and negative “-” polarities.
- Use batteries of the same type. Never use different types of batteries together.
- Either rechargeable or non-rechargeable batteries can be used. Refer to the precautions on their labels.
- Be aware of your fingernails when removing the battery cover and the battery.
- Do not drop the remote control.
- Do not allow anything to impact the remote control.
- Do not spill water or any liquid on the remote control.
- Do not place the remote control on a wet object.
- Do not place the remote control under direct sunlight or near sources of excessive heat.
- Remove the battery from the remote control when not in use for a long period of time, as corrosion or battery leakage may occur and result in physical injury, and/or property damage, and/or fire.
- Do not use any batteries other than those specified.
- Do not mix new batteries with old ones.
- Never recharge a battery unless it is confirmed to be a rechargeable type.

## 5. Placement and Mounting

### 5.1 Placement

- A If your TV is placed on a table, you can place the Soundbar on the table directly in front of the TV stand, centered with the TV screen.
- B If your TV is attached to a wall, you can mount the Soundbar on the wall directly below the TV screen.

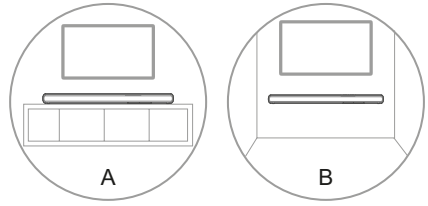

### 5.2 Wall Mounting (if using option-B)

- Installation must be carried out by qualified personnel only. Incorrect assembly can result in severe personal injury and property damage (if you intend to install this product yourself, you must check for installations such as electrical wiring and plumbing that may be buried inside the wall). It is the installer's responsibility to verify that the wall will safely support the total load of the Soundbar and wall brackets.
- Additional tools (not included) are required for the installation.
- Do not overtighten screws.
- Keep this instruction manual for future reference.
- Use an electronic stud finder to check the wall type before drilling and mounting.

#### WARNING

- To prevent injury, this apparatus must be securely attached to the floor/wall in accordance with the installation instructions.
- Suggested wall mounting height:  $\leq 1.5$  meters.

1. Drill 4 parallel holes ( $\varnothing 5.5-6$  mm each according to wall type) in the wall. The distance between the holes should be 892 mm.
2. Firmly fix 1 dowel into each hole in the wall if necessary. Tighten the wall mount brackets on the wall with screws and screwdriver (not included). Make sure that they are securely installed.
3. Remove the screws at the back of the Soundbar. Install the wall mounting screws into the back of the Soundbar.
4. Lift the Soundbar onto the wall mount brackets and slot into place.

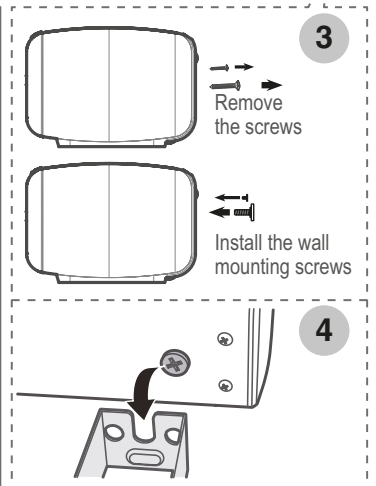
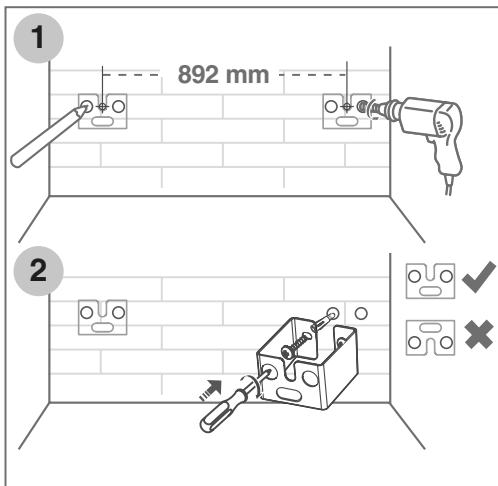
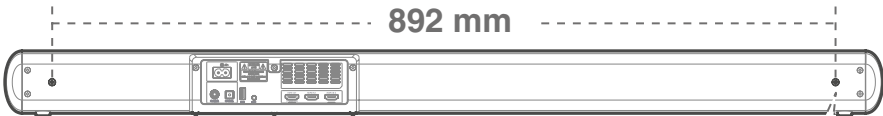

## 6. Connections

### 6.1 Dolby Atmos®

Dolby Atmos gives you Immersive listening experience by delivering sound in three dimensional space, and all the richness, clarity, and power of Dolby sound.

For more information, please visit [dolby.com/technologies/dolby-atmos](http://dolby.com/technologies/dolby-atmos)

#### For using Dolby Atmos®

Dolby Atmos® is available only in HDMI mode. For the details of the connection, please refer to “**HDMI Connection**”.

1. To use Dolby Atmos® in HDMI 1 / HDMI 2 / HDMI ARC mode, your TV has to support Dolby Atmos®.
2. Make sure that “No Encoding” is selected for bitstream in the audio output of the connected external device (e.g. Blu-ray DVD player, TV etc.).
3. While entering Dolby Atmos / Dolby Digital / PCM format, the soundbar will show DOLBY ATMOS / DOLBY AUDIO / PCM AUDIO.

### 6.2 HDMI Connection

Some 4K HDR TVs require the HDMI input or picture settings to be set for HDR content reception. For further setup details on HDR display, please refer to the instruction manual of your TV.

#### Method 1: ARC (Audio Return Channel)

The ARC (Audio Return Channel) function allows you to send audio from your ARC-compliant TV to your soundbar through a single HDMI connection. To enjoy the ARC function, please ensure your TV is both HDMI-CEC and ARC compliant and set up accordingly. When correctly set up, you can use your TV remote control to adjust the volume output (VOL +/- and MUTE) of the soundbar.

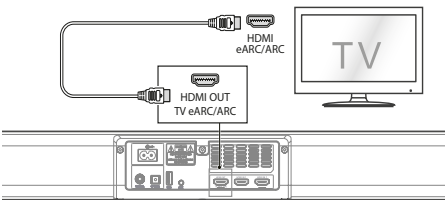

- Connect the HDMI cable from unit's **HDMI OUT (TV eARC/ARC)** socket to the HDMI (ARC) socket on your ARC compliant TV. Then press the remote control to select **HDMI (TV eARC/ARC)**.

#### Tips:

- Your TV must support the HDMI-CEC and ARC function. HDMI-CEC and ARC must be set to On.
- The setting method of HDMI-CEC and ARC may differ depending on the TV. For details about ARC function, please refer to the owner's manual.
- ARC only works with devices that are HDMI ARC capable as well as with an HDMI 1.4 cable (and higher).

#### Method 2: Standard HDMI

- If your TV is not HDMI ARC-compliant, connect your soundbar to the TV through a standard HDMI connection.

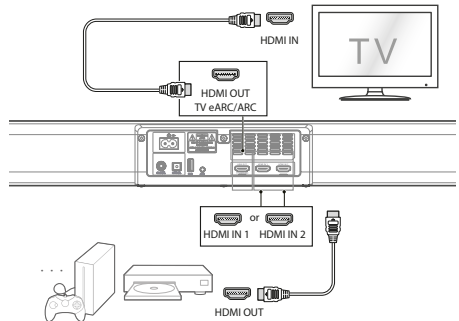

1. Use an HDMI cable to connect the soundbar's **HDMI OUT (TV eARC/ARC)** socket to the TV's HDMI IN socket.
2. Use an HDMI cable to connect the soundbar's **HDMI IN (1 or 2)** socket to your external devices (e.g. games consoles, DVD players and Blu-ray).

### 6.3 Use the OPTICAL Socket

- Remove the protective cap of the **OPTICAL** socket, then connect an OPTICAL cable (not included) to the TV's OPTICAL OUT socket and the **OPTICAL** socket on the Soundbar.

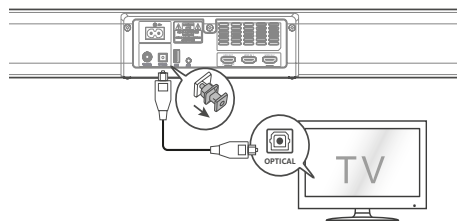

## 6.4 Use the COAXIAL Socket

- You also can use the COAXIAL cable (not included) to connect the TV's COAXIAL OUT socket and **COAXIAL** socket on the Soundbar.

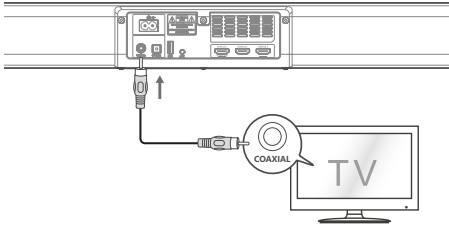

**Tips:** The Soundbar may not be able to decode all digital audio formats from the input source. In this case, the Soundbar will mute. This is NOT a defect. Ensure that the audio setting of the input source (e.g. TV, game console, DVD player, etc.) is set to **PCM** or **Dolby Digital** (Refer to the user manual of the input source device for its audio setting details) with HDMI / OPTICAL / COAXIAL input.

## 6.5 Use the AUX Socket

- A. Use a RCA to 3.5mm audio cable (not included) to connect the TV's audio output sockets to the **AUX** socket on the Soundbar.

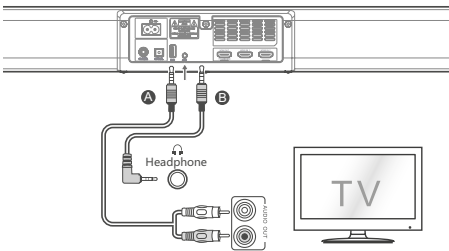

- B. Use a 3.5mm to 3.5mm audio cable (included) to connect the TV's or external audio device headphone socket to the **AUX** socket on the Soundbar.

## 6.6 Connect Power

- Risk of product damage!** Ensure that the power supply voltage corresponds to the voltage printed on the back or the underside of the Soundbar.
- Before connecting the AC power cord, ensure you have completed all other connections.

## • Soundbar

Connect the mains cable to the **AC~** Socket of the Soundbar and then into a mains socket.

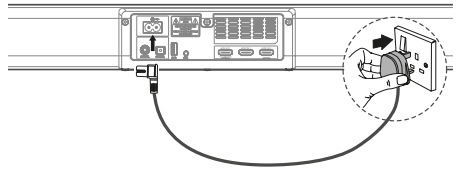

## 7. Basic Operation

### 7.1 Standby/ON

When you first connect the Soundbar to the mains socket, the Soundbar will be in Standby mode.

- Press the **⏻** button on the Soundbar or on the remote control to switch the Soundbar ON.
- Press the **⏻** button again to switch the Soundbar back to STANDBY mode.
- Disconnect the mains plug from the mains socket if you want to switch the Soundbar OFF completely.

### 7.2 Automatic Power Off Function

The Soundbar automatically turns to **Standby** mode after about 60 minutes if the TV or the external unit is disconnected, switched off or the volume is too close to mute.

- To switch the Soundbar off completely, remove the mains plug from the mains socket.
- Please turn the Soundbar off completely to save energy when not in use.

### 7.3 Select Modes

Press the **⏮** (SOURCE) button on the Soundbar or the **AUX**, **BT**, **OPT/COA**, **HDMI 1/2**, **HDMI eARC** and **USB** buttons on the remote control to select the desired mode. The selected mode will show on the display.

### 7.4 Adjust the Bass/Treble Level

- Press the **BASS +/-** buttons on the remote control to adjust bass level.
- Press the **TREBLE +/-** buttons on the remote control to adjust treble level.

## 7.5 Turn the Surround Sound ON/OFF

- Press the **VERTICAL/SURROUND** button on the remote control to turn on the surround sound. Press this button again to turn off the surround sound.

## 7.6 Select Equalizer (EQ) Effect

Press the **VOICE / SPORT / MOVIE / MUSIC** buttons on the remote control to select your desired preset equalizer effects.

## 7.7 Adjust the Volume

- Press the **+/- (VOL)** buttons on the Soundbar or on the remote control to adjust the volume.
- If you wish to turn the sound off, press the **MUTE** button on the Soundbar or on the remote control. Press the **MUTE** button or **+/- (VOL)** buttons again on the Soundbar or on the remote control to resume normal listening.

## 7.8 Adjust the Brightness

- Press the **DIMMER** button on the remote control to select brightness level.

## 8. AUX/OPTICAL/COAXIAL/HDMI Operation

- 1 Ensure that the Soundbar is connected to the TV or audio device.
- 2 Press the  button repeatedly on the Soundbar or the **AUX, OPT/COA, HDMI 1/2, HDMI eARC** buttons on the remote control to select the desired mode. The selected mode will show on the display.
- 3 Operate your audio device directly for playback features.
- 4 Press the **+/- (VOL)** button to adjust the volume to your desired level.

### Tip:

- The Soundbar may not be able to decode all digital audio formats from the input source. In this case, the Soundbar will mute. This is NOT a defect. Ensure that the audio setting of the input source (e.g. TV, game console, DVD player, etc.) is set to **PCM** or **Dolby Digital** (Refer to the user manual of the input source device for its audio setting details) with

HDMI 1 / HDMI 2 / HDMI ARC / OPTICAL / COAXIAL input.

- When selecting a different audio format, the Soundbar will display the following as follows:

Audio (abbreviation)	Display
LPCM 2ch	PCM AUDIO
LPCM 5.1ch	PCM AUDIO
LPCM 7.1ch	PCM AUDIO
Dolby Digital	DOLBY AUDIO
Dolby TrueHD	DOLBY AUDIO
Dolby Digital Plus	DOLBY AUDIO
Dolby Atmos - Dolby TrueHD	DOLBY ATMOS
Dolby Atmos - Dolby Digital Plus	DOLBY ATMOS

## 9. USB Operation

By connecting a USB mass storage device (e.g. USB flash drive) to this unit, you can enjoy the device's stored music through the Soundbar.

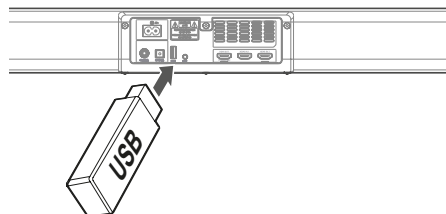

1. Press the  button on the Soundbar or press the **USB** button on the remote control to select **USB** mode.
2. Press the **|||** button on the remote control to pause/resume playback.
3. To skip to a track, press the **◀▶** buttons.



- The player supports the USB music file format of MP3 only.
- The Soundbar can support USB devices with up to 32 GB of memory.
- The Soundbar may not be compatible with all USB devices, this is not an indication of a problem with the unit.

## 10. Bluetooth® Operation

Pairing the Soundbar with a Bluetooth® device to listen to music:

### First time pairing

1. With the soundbar powered on, press the  (**Bluetooth**) button on the Soundbar or press the **BT** button on the remote control to select Bluetooth® mode. The display will show **NO BT**.
2. Activate your Bluetooth® device and select the search mode. "**Azatom Elite**" will appear on your Bluetooth® device list.
3. Select "**Azatom Elite**" enter "0000" for the password if necessary. The Soundbar will voice "**Paired**" and the display will show **BT**.

### Pairing a new device after first time pairing

1. In Bluetooth® mode, press and hold the  button to clear all pairing. The Soundbar will enter pairing mode. The Soundbar will voice "**Pairing**" and the display will show "**PAIR**".
2. Follow step 2-3 to pair your Bluetooth® device.

### To disconnect the Bluetooth® function, you can:



- Switch to another function on the Soundbar;
- Disable the function from your Bluetooth® device.
- Press and hold the  button on the remote control. The Bluetooth® device will be disconnected from the soundbar after the "**Pairing**" voice prompt.

The display will show **PAIR**, and the Soundbar is now ready for pairing. Follow step 2-3 in "**First time pairing**" above to pair your Bluetooth® device.

### Listen to Music from Bluetooth® device

If your Bluetooth® device supports A2DP, play music via your device.

If your Bluetooth® device supports AVRCP, use the supplied remote control to control play.

- To increase/decrease the volume, press **+/- (VOL)** button.
- To pause/resume playback, press  button.
- To skip to a track, press  /  button.



- The operational range between the Soundbar and the device is approximately 8 metres.
- Before connecting a Bluetooth® device to the unit, ensure you know the device's capabilities.
- Compatibility with all Bluetooth® devices is not guaranteed.
- Any obstacle between the device and the Soundbar can reduce operational range.
- Keep this player away from other electronic devices that may cause interference.
- The player will also be disconnected when your device is moved beyond the operational range.

# 11.Troubleshooting

To keep the warranty valid, never try to repair the system yourself. If you encounter problems when using this unit, check the following points before requesting service.

Problem	Solution
<b>No power</b>	<ul style="list-style-type: none"> <li>• Ensure that the AC cord of the apparatus is properly connected .</li> <li>• Ensure that there is power at the AC outlet.</li> <li>• Press ⏻ (standby) button to turn the Soundbar on.</li> </ul>
<b>Remote control does not work</b>	<ul style="list-style-type: none"> <li>• Before you press any playback control button, first select the correct source.</li> <li>• Reduce the distance between the remote control and the Soundbar.</li> <li>• Insert the battery with its polarities (+/-) aligned as indicated.</li> <li>• Replace the battery.</li> <li>• Aim the remote control directly at the sensor on the front of the Soundbar.</li> </ul>
<b>No sound</b>	<ul style="list-style-type: none"> <li>• Make sure that the Soundbar is not muted. Press MUTE or +/- (VOL) button to resume normal listening.</li> <li>• Press ⏻ button on the Soundbar or on the remote control to switch the Soundbar to standby mode. Then press the ⏻ button again to switch the Soundbar on.</li> <li>• Ensure the audio setting of the input source (e.g. TV, game console, DVD player, etc.) is set to PCM or Dolby Digital mode while using digital (e.g. HDMI, OPTICAL, COAXIAL) connection.</li> <li>• The Soundbar may not be able to decode all digital audio formats from the input source. In this case, the Soundbar will mute. This is NOT a defect.device is not muted.</li> <li>• If using Bluetooth, ensure that the volume on your source device is turned up and that the device is not muted.</li> </ul>
<b>TV has display problem while viewing HDR content from HDMI source.</b>	<ul style="list-style-type: none"> <li>• Some 4K HDR TVs require the HDMI input or picture settings to be set for HDR content reception. For further setup details on HDR display, please refer to the instruction manual of your TV.</li> </ul>
<b>I can't find the Bluetooth name of this unit on my Bluetooth device for Bluetooth pairing</b>	<ul style="list-style-type: none"> <li>• Ensure the Bluetooth function is activated on your Bluetooth device.</li> <li>• Re-pair the Soundbar with your Bluetooth device.</li> <li>• The Soundbar has a Bluetooth® function that can receive a signal within 8 metres. Keep a distance within 8 metres between the Soundbar and your Bluetooth® device.</li> </ul>
<b>Can't achieve outstanding Dolby Atmos® effects.</b>	<ul style="list-style-type: none"> <li>• For non-HDMI connections (such as use of USB, Bluetooth, OPTICAL or AUDIO IN), limited height Surround effects are generated. See the section of 'Dolby Atmos®' about how to achieve best Dolby Atmos® effects.</li> </ul>

## 12. Specifications

Brand	AZATOM
Model	Elite AT1

### Soundbar

Power Supply	100-240V~ 50/60Hz
Power Consumption	48 W < 0.5 W (StandBy)
Speakers Impedance	8Ω x 2 + 4Ω
USB	5V $\overline{\text{---}}$ 500mA Hi-Speed USB (2.0) / FAT32 / FAT16 32G (max) , MP3
Dimension (WxHxD)	1000 x 74 x 105.4 mm
Net weight	2.7 kg
Audio input sensitivity	700mV
Frequency Response	40Hz - 20KHz

### Wireless Specification

Bluetooth version / profiles	V 5.3 (A2DP, AVRCP)
Bluetooth frequency range	2402 MHz ~ 2480 MHz
Bluetooth Max. transmitting power	≤ 10 dBm
Modulation Type	GFSK, $\pi/4$ DQPSK

### Amplifier (RMS Output power)

Total (RMS)	120 W (RMS) 30W x 2 + 60W
Maximum output power	240 W (Max)

### Remote Control

Distance/Angle	19.7 feet (6m) / 30°
Battery type	AAA (1.5V x 2)

- Design and specifications are subject to change without notice.

Register your product online. To learn more & register for our AZATOM warranty  
PLEASE VISIT: [www.azatom.com/warranty](http://www.azatom.com/warranty) or scan the QR code.



AZATOM© 2020 All rights reserved. AZATOM® is part of AZATOM Group Limited.  
AZATOM® Reserve the right to withdraw any and all promotions without notice, full warranty, extended warranty and promotional offer terms & conditions. Please visit [www.azatom.com/terms-conditions](http://www.azatom.com/terms-conditions)

Add: AZATOM Group Limited, Tees Valley Court, Wynyard Business Park, Billingham, TS22 5FE. United Kingdom.  
Contact: [customersupport@azatom.com](mailto:customersupport@azatom.com) Tel: (+44) 01740 629901



@AZATOM



This manual is available to download online at [www.azatom.com](http://www.azatom.com)

**AZATOM® 2020 ALL RIGHTS RESERVED. AZATOM® IS PART OF AZATOM GROUP LIMITED. SEE SITE FOR SAFETY INFORMATION. AZATOM® RESERVE THE RIGHT TO WITHDRAW ANY AND ALL PROMOTIONS WITHOUT NOTICE. FOR FULL WARRANTY, EXTENDED WARRANTY AND PROMOTIONAL OFFER TERMS & CONDITIONS PLEASE VISIT [WWW.AZATOM.COM/TERMS-CONDITIONS](http://WWW.AZATOM.COM/TERMS-CONDITIONS)**